



US 20200044182A1

(19) **United States**

(12) **Patent Application Publication**
Qiao et al.

(10) **Pub. No.: US 2020/0044182 A1**

(43) **Pub. Date: Feb. 6, 2020**

(54) **ORGANIC LIGHT-EMITTING DISPLAY
PANEL AND ORGANIC LIGHT-EMITTING
DISPLAY APPARATUS**

(52) **U.S. Cl.**
CPC *H01L 51/5221* (2013.01); *H01L 27/3244*
(2013.01); *H01L 51/5072* (2013.01); *H01L*
2251/552 (2013.01); *H01L 51/5092* (2013.01);
H01L 51/5262 (2013.01); *H01L 51/5004*
(2013.01)

(71) Applicant: **Shanghai Tianma AM-OLED Co.,
Ltd., Shanghai (CN)**

(72) Inventors: **Weili Qiao, Shanghai (CN); Jinghua
Niu, Shanghai (CN); Xiaoqian Sun,
Shanghai (CN)**

(57) **ABSTRACT**

(73) Assignee: **Shanghai Tianma AM-OLED Co.,
Ltd., Shanghai (CN)**

Provided are an organic light-emitting display panel and an organic light-emitting display apparatus. The organic light-emitting display panel includes an array base substrate including a plurality of driving elements, and includes a plurality of organic light-emitting devices. Each of the plurality of organic light-emitting devices is corresponding to a respective one of the plurality of driving elements, and the each of the plurality of organic light-emitting devices includes an anode and a cathode, a cathode, an organic luminous layer, an electron transport layer, and a transition layer. The organic luminous layer is disposed between the anode and the cathode, the electron transport layer is disposed between the luminous layer and the cathode, and the transition layer is disposed between the cathode and the electron transport layer, and the transition layer includes an organic material.

(21) Appl. No.: **16/244,227**

(22) Filed: **Jan. 10, 2019**

(30) **Foreign Application Priority Data**

Aug. 1, 2018 (CN) 201810862737.2

Publication Classification

(51) **Int. Cl.**
H01L 51/52 (2006.01)
H01L 27/32 (2006.01)
H01L 51/50 (2006.01)

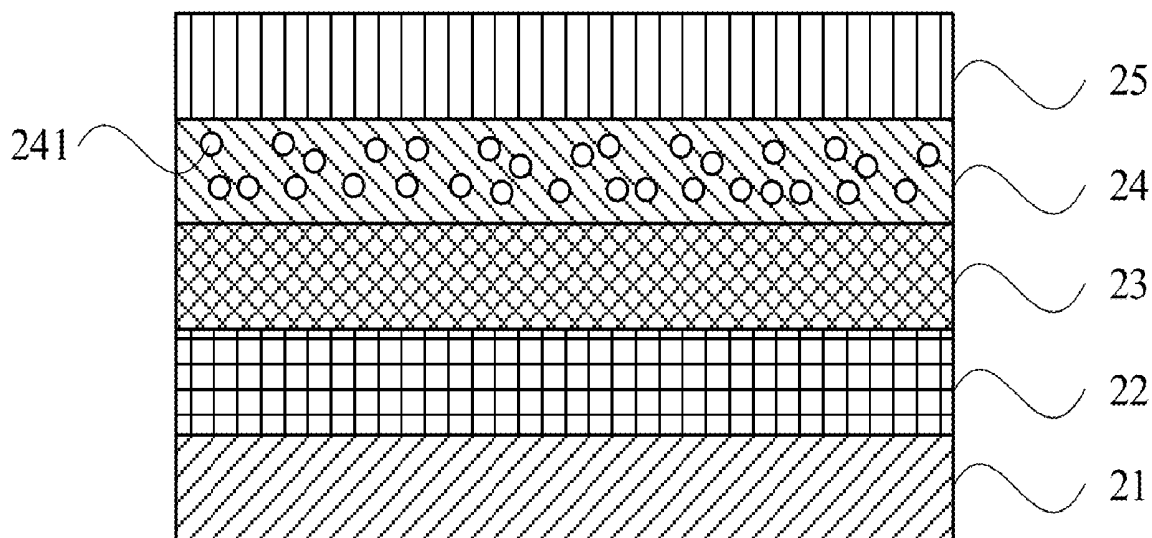

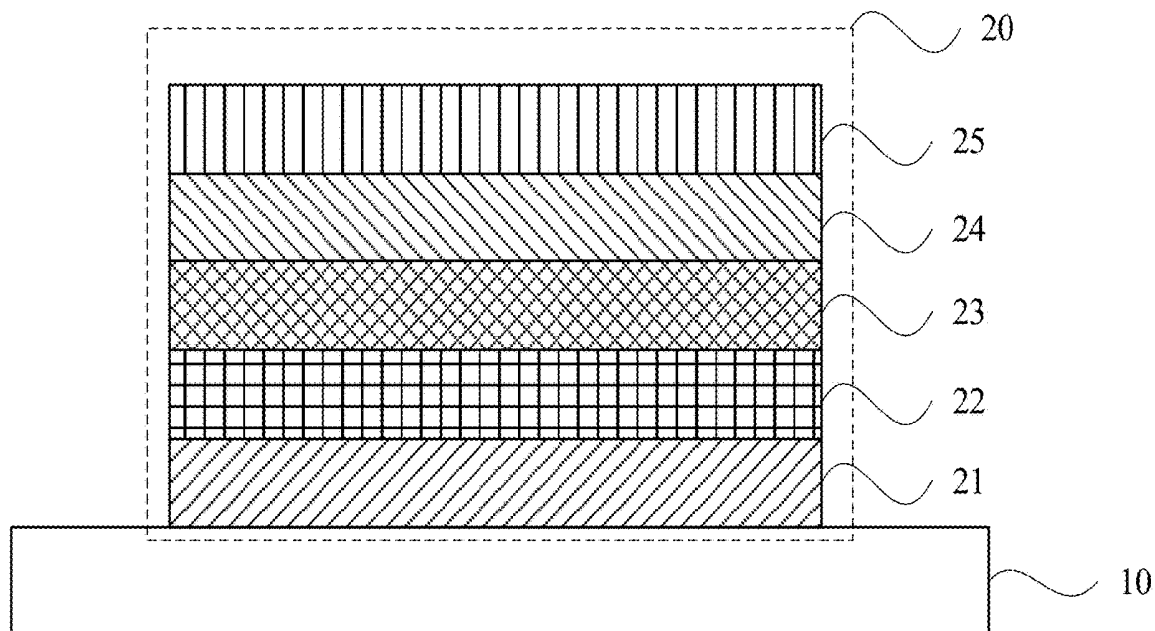

FIG. 1

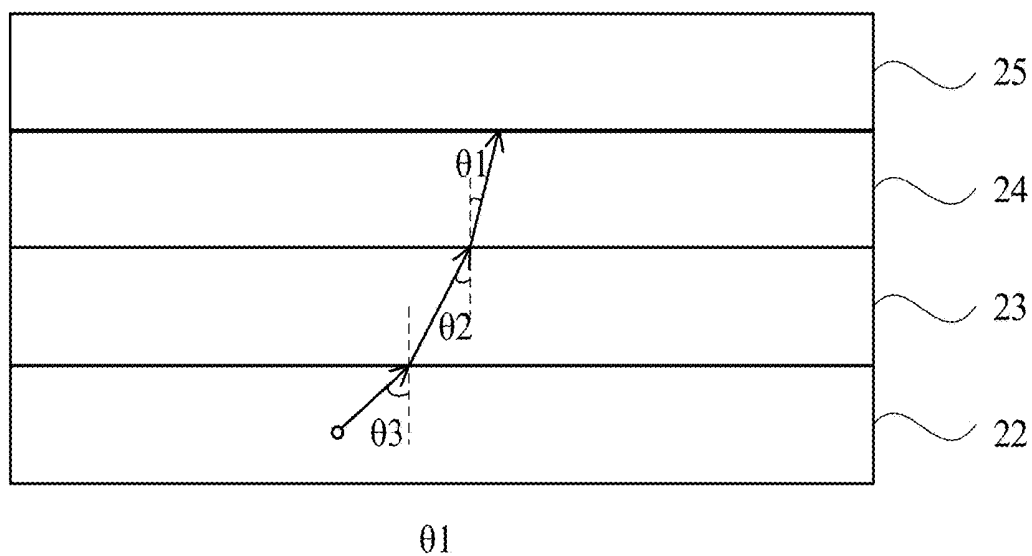

FIG. 2

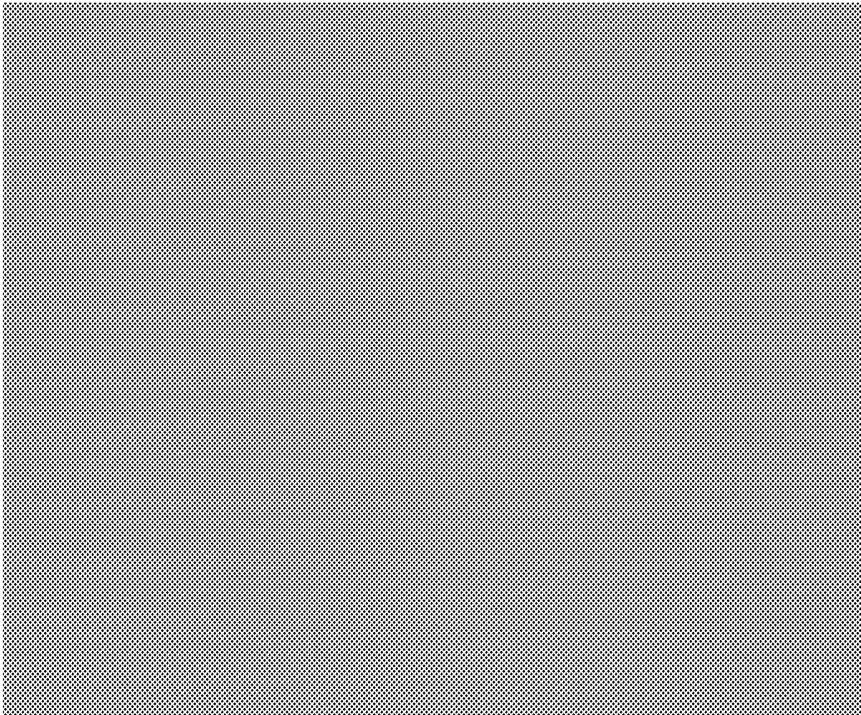

FIG. 3

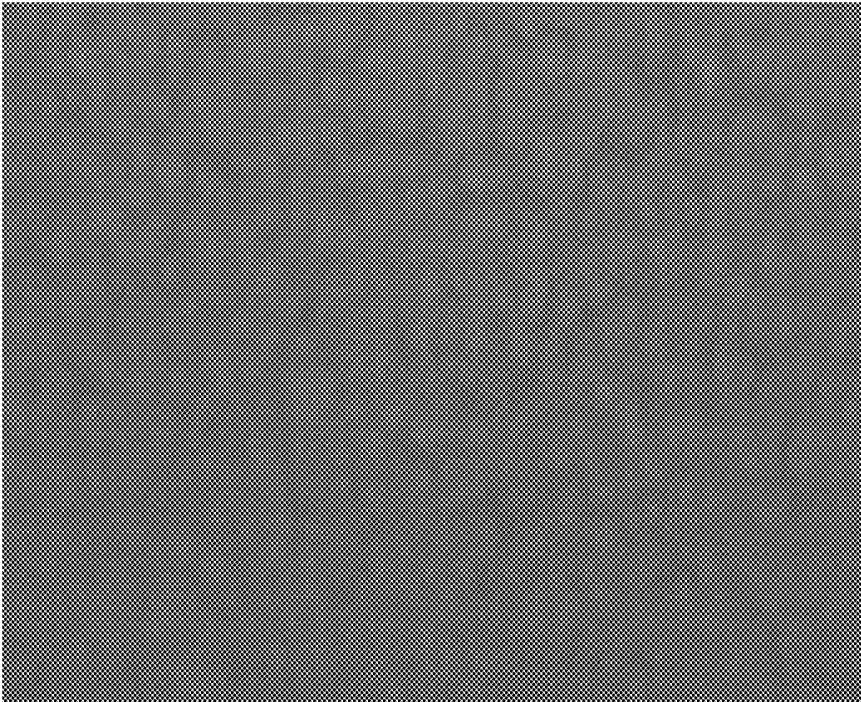

FIG. 4

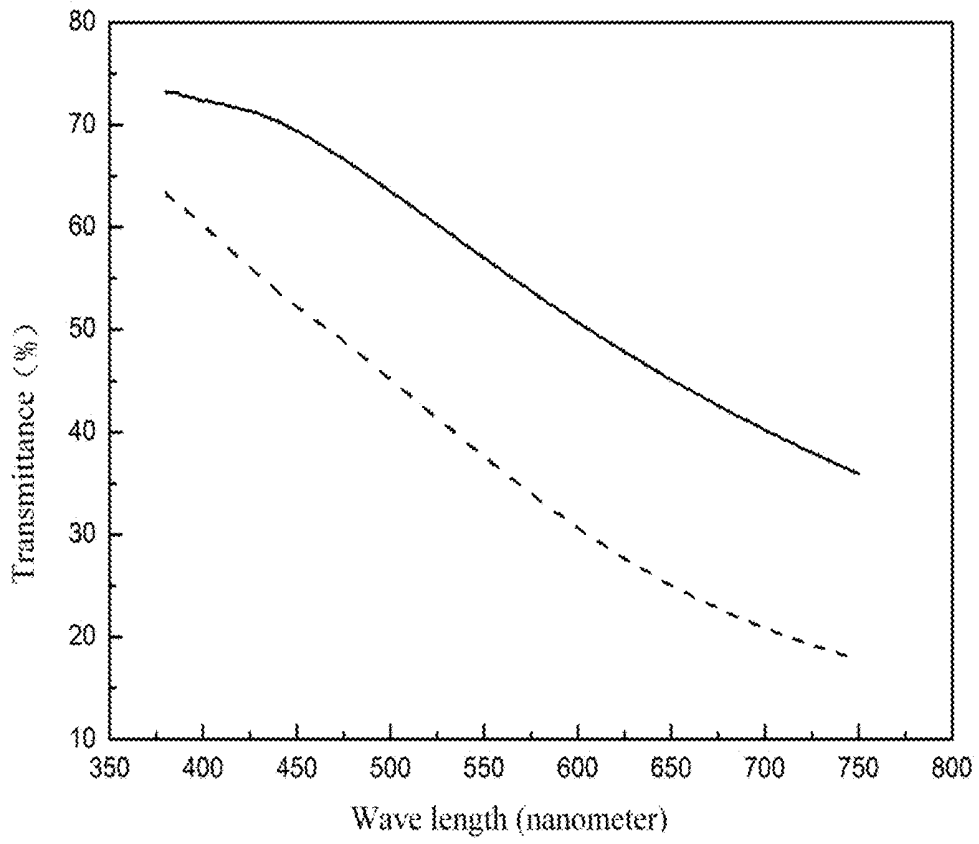

FIG. 5

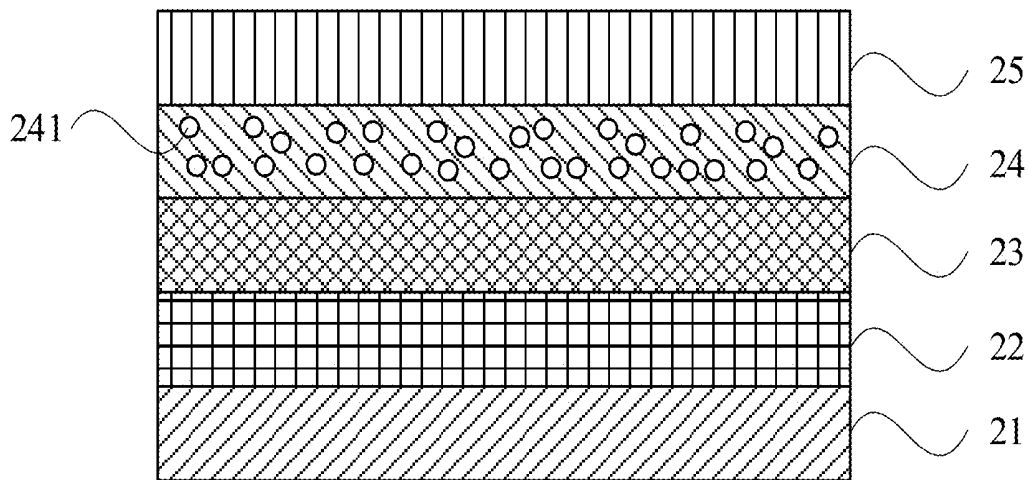

FIG. 6

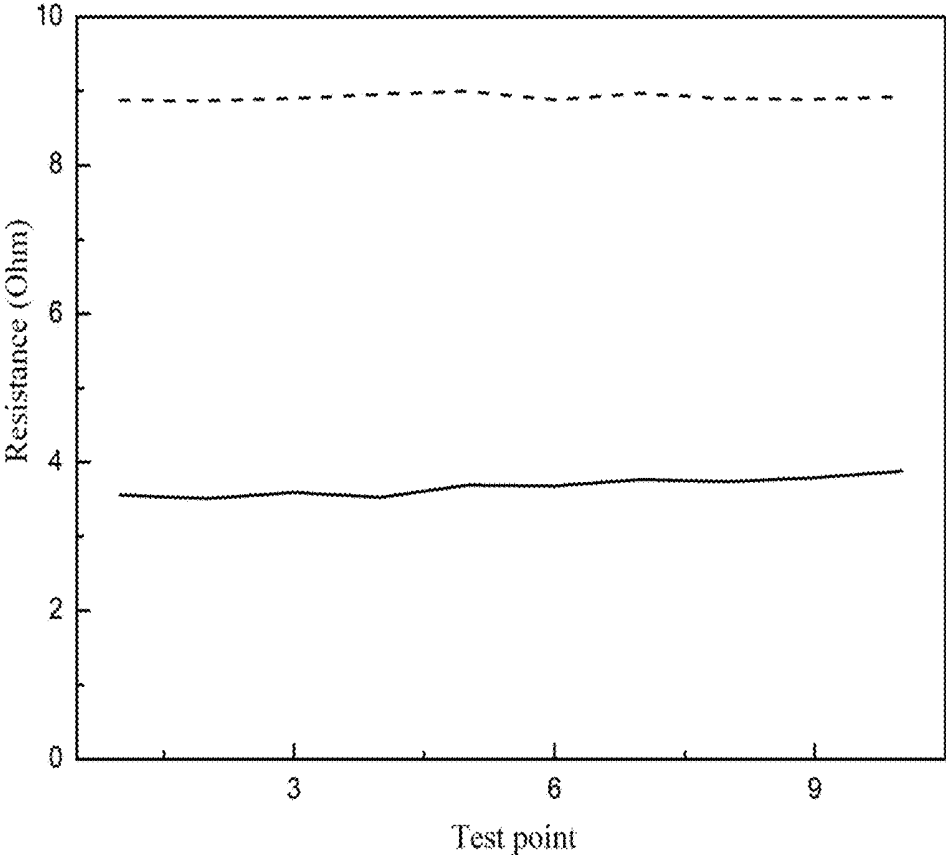

FIG. 7

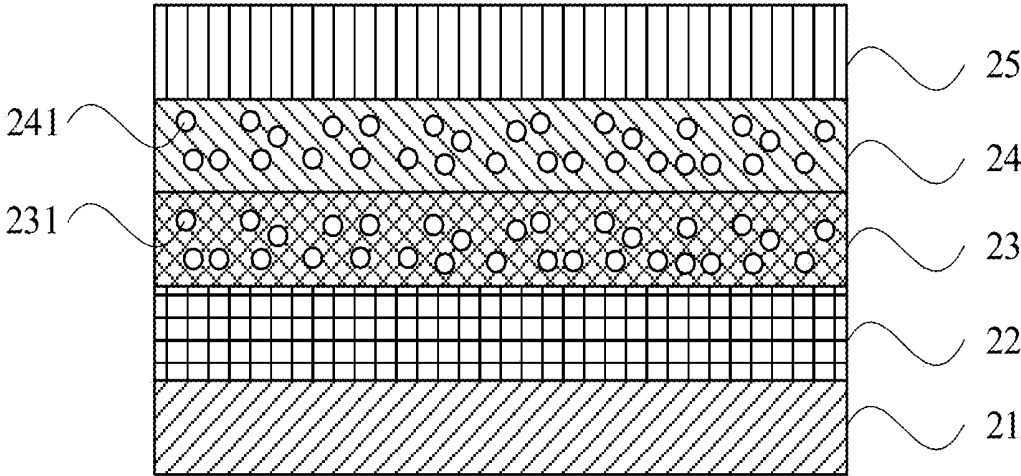

FIG. 8

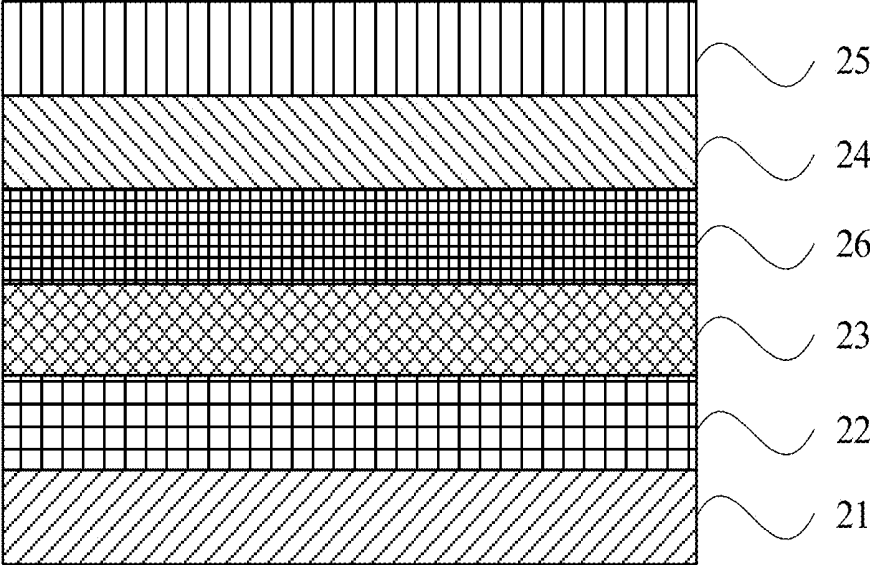

FIG. 9

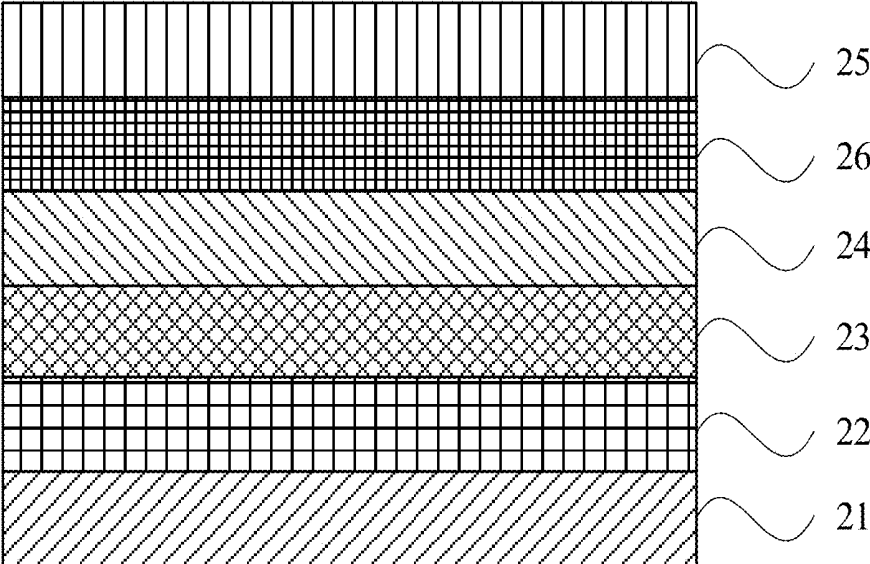

FIG. 10

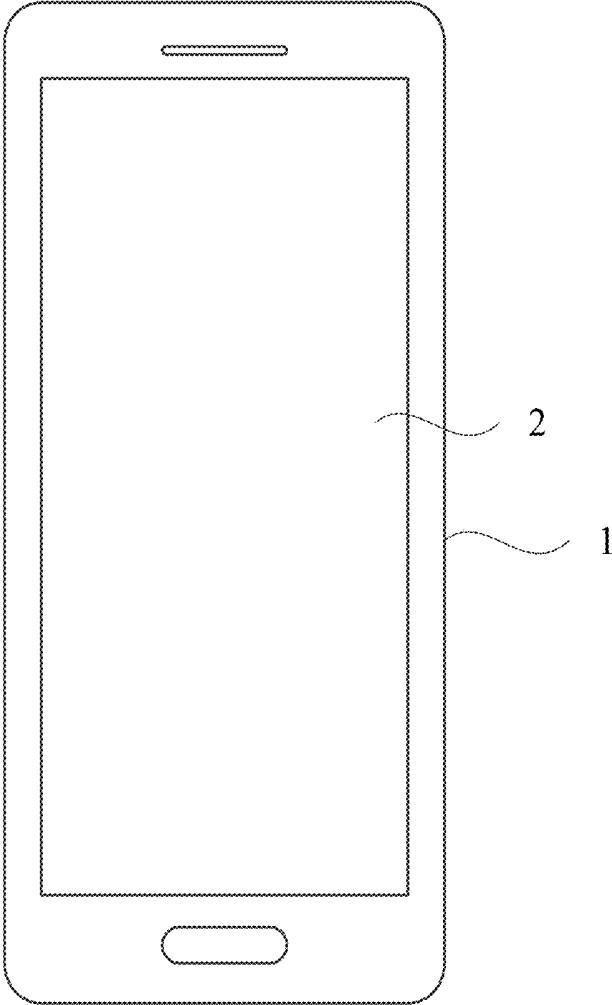

FIG. 11

**ORGANIC LIGHT-EMITTING DISPLAY
PANEL AND ORGANIC LIGHT-EMITTING
DISPLAY APPARATUS**

CROSS-REFERENCE TO RELATED
APPLICATIONS

[0001] This application claims priority to Chinese patent application No. 201810862737.2 filed on Aug. 1, 2018, the disclosure of which is incorporated herein by reference in its entirety.

TECHNICAL FIELD

[0002] The present disclosure relates to display technologies, and in particular relates to an organic light-emitting display panel and an organic light-emitting display apparatus.

BACKGROUND

[0003] Organic light-emitting diode OLED display technology has the advantages of spontaneous light, wide viewing angle, almost infinite contrast, low power consumption and high reaction speed and the like. The OLED display technology is widely used in various display fields such as mobile phone, digital camera, personal digital assistant (PDA), laptop, car audio and television.

[0004] In related arts, the OLED includes a cathode, an electron transport layer, a luminous layer, a hole transport layer, an anode and a base substrate. When the OLED is in operation, a bias voltage is applied between the anode and the cathode, holes move from the hole transport layer to the luminous layer, and electrons move from the electron transport layer to the emitting material layer. On the luminous layer, electrons and holes combine to produce excitons. Excitons are unstable and release energy, the released energy is transferred to the molecules of organic light-emitting material in the luminous layer, causing the molecules of organic light-emitting material to transmit from the ground state to the excited state. The excited state is very unstable, the excited molecules return to the ground state from the excited state, and such radiative transition produces luminescence. In an OLED in related arts, when the cathode of the OLED is formed by co-evaporation of magnesium and silver, the thickness of the cathode is too thin, and the cathode is easy to form in an island shape. When the cathode of the OLED is formed by silver separately, it is easy to gather and form defects, and when the thickness of the cathode is greater than 20 nm (greater than 200 Å), the light transmittance deteriorates, leading to lower OLED luminous efficiency.

SUMMARY

[0005] The present disclosure provides an organic light-emitting display panel and an organic light-emitting display apparatus so as to improve the light extraction rate and effectively improve the luminous efficiency.

[0006] In a first aspect, the present disclosure provides an organic light-emitting display panel, and the organic light-emitting display panel includes an array base substrate including a plurality of driving elements, and includes a plurality of organic light-emitting devices. Each of the plurality of organic light-emitting devices is corresponding to a respective one of the plurality of driving elements, and the each of the plurality of organic light-emitting devices

includes an anode, a cathode, an organic luminous layer, an electron transport layer and a transition layer.

[0007] The organic luminous layer is disposed between the anode and the cathode. The electron transport layer is disposed between the luminous layer and the cathode. The transition layer is disposed between the cathode and the electron transport layer, and the transition layer includes organic material.

[0008] A refractive index n_1 of the transition layer for visible light with a wavelength of 500 nm and a refractive index n_2 of the electron transport layer for the visible light with the wavelength of 500 nm satisfy that $0.05 \leq n_1 - n_2 \leq 0.4$.

[0009] A lowest unoccupied orbital energy level LUMO1 of the transition layer and a work function ϕ_1 of the cathode satisfy that $0 \text{ eV} \leq |LUMO1 - \phi_1| \leq 2.6 \text{ eV}$.

[0010] A lowest unoccupied orbital energy level LUMO2 of the electron transport layer and the lowest unoccupied orbital energy level LUMO1 of the transition layer satisfy that $0.4 \text{ eV} \leq |LUMO1 - LUMO2| \leq 1 \text{ eV}$.

[0011] In a second aspect, the present disclosure further provides an organic light-emitting display apparatus, and the organic light-emitting display apparatus includes any organic light-emitting display panel provided in embodiments of the present disclosure.

[0012] The organic light-emitting display panel provided in embodiments of the present disclosure includes an array base substrate including a plurality of driving elements, and includes plurality of organic light-emitting devices. Each of the plurality of organic light-emitting devices is corresponding to a respective one of the plurality of driving elements, and the each of the plurality of organic light-emitting devices includes an anode, a cathode, an organic luminous layer, an electron transport layer, and a transition layer. The luminous layer is disposed between the anode and the cathode. The electron transport layer is disposed between the organic luminous layer and the cathode. The transition layer is disposed between the cathode and the electron transport layer, and the transition layer includes organic material. The embodiments of the present disclosure provides an arrangement that a refractive index n_1 of the transition layer for visible light with the wavelength of 500 nm and a refractive index n_2 of the electron transport layer for the visible light with the wavelength of 500 nm satisfy that $0.05 \leq n_1 - n_2 \leq 0.4$, that is the refractive index of the transition layer is greater than the refractive index of the electron transport layer. Such arrangement can avoid full reflection of light emitted by the organic luminous layer when the light passes through the interface between the electron transport layer and the transition layer, improving the extraction rate of light. The embodiments of the present disclosure provide an arrangement that a lowest unoccupied orbital energy level LUMO1 of the transition layer and a work function ϕ_1 of the cathode satisfy that $0 \text{ eV} \leq |LUMO1 - \phi_1| \leq 2.6 \text{ eV}$, which can facilitate migration of electron carriers. The embodiments of present disclosure provided an arrangement that a lowest unoccupied orbital energy level LUMO2 of the electron transport layer and the lowest unoccupied orbital energy level LUMO1 of the transition layer satisfy that $0.4 \text{ eV} \leq |LUMO1 - LUMO2| \leq 1 \text{ eV}$, and a difference of lowest energy level between the electron transport layer and the transition layer is small, which can reduce electron injection potential barrier and facilitate more electrons to be injected into the organic luminous layer, so as to improve the light extraction rate of organic light-emitting devices, effectively improve

the luminous efficiency and improve the performance of the organic light-emitting display panel.

BRIEF DESCRIPTION OF DRAWINGS

[0013] FIG. 1 is a structure diagram of an organic light-emitting display panel according to an embodiment of the present disclosure.

[0014] FIG. 2 is a diagram showing light transport route between an organic luminous layer and a cathode according to an embodiment of the present disclosure.

[0015] FIG. 3 is a morphology micrograph of a cathode of an organic light-emitting device according to an embodiment of the present disclosure.

[0016] FIG. 4 is a morphology micrograph of a cathode of an organic light-emitting device according to a comparison embodiment of the present disclosure.

[0017] FIG. 5 is a comparison diagram showing light transmittance of an organic light-emitting device according to a comparison embodiment and an embodiment of the present disclosure.

[0018] FIG. 6 is a structure diagram of an organic light-emitting device according to an embodiment of the present disclosure.

[0019] FIG. 7 is a comparison diagram showing a cathode sheet resistance of an organic light-emitting device according to a comparison embodiment and an embodiment of the present disclosure.

[0020] FIG. 8 is a structure diagram of an organic light-emitting device according to an embodiment of the present disclosure.

[0021] FIG. 9 is a structure diagram of another organic light-emitting device according to an embodiment of the present disclosure.

[0022] FIG. 10 is a structure diagram of another organic light-emitting device according to an embodiment of the present disclosure.

[0023] FIG. 11 is structure diagram of a display apparatus according to an embodiment of the present disclosure.

DETAILED DESCRIPTION

[0024] The present disclosure is further detailed below in combination with the drawings and embodiments. It should be understood that, the specific embodiments described herein are merely used to explain the present disclosure rather than limiting the present disclosure. In addition, it should be stated that in order to facilitate the description, merely a part of structure related to the present disclosure rather than the whole structure are illustrated in the drawings.

[0025] Terms used in embodiments of the present disclosure are only for the purpose to describe a specific example, rather than to limit the present disclosure. It should be noted that locative words in embodiments of the present disclosure such as “up” and “down”, “left” and “right” and other words are described from the view of drawings, rather than to limit the present disclosure. In context, it also needs to understand that when it comes to a component that is formed “above” or “below” another element, it can not only form directly “above” or “below” another element, but also form indirectly “above” or “below” another element through an intermediate component. The terms “first”, “second”, and the like are only used to describe, and does not mean any sequence, quantity or importance, only to distinguish dif-

ferent components. For those skilled in the art, the specific meaning of the above mentioned terms in the present disclosure can be understood in specific cases.

[0026] FIG. 1 is a structure diagram of an organic light-emitting display panel according to an embodiment of the present disclosure. As shown in FIG. 1, the organic light-emitting display panel includes an array base substrate 10, and the array base substrate 10 includes a plurality of driving elements (not shown in drawings). The organic light-emitting display panel further includes a plurality of organic light-emitting devices 20, each light-emitting device 20 is corresponding to a respective one of the plurality of driving elements, and the each light-emitting device 20 includes an anode 21, a cathode 25, an organic luminous layer 22, an electron transport layer 23, and a transition layer 24. The organic luminous layer 22 is disposed between the anode 21 and the cathode 25. The electron transport layer 23 is disposed between the organic luminous layer 22 and the cathode 25. The transition layer 24 is disposed between the cathode 25 and the electron transport layer 23, and the transition layer 24 includes an organic material. A refractive index n_1 of the transition layer 24 for the visible light with a wavelength of 500 nm and a refractive index n_2 of the electron transport layer 23 for the visible light with the wavelength of 500 nm satisfy that $0.05 \leq n_1 - n_2 \leq 0.4$. A lowest unoccupied orbital energy level LUMO1 of the transition layer 24 and a work function ϕ_1 of the cathode 25 satisfy that $0 \text{ eV} \leq |LUMO1 - \phi_1| \leq 2.6 \text{ eV}$. A lowest unoccupied orbital energy level LUMO2 of the electron transport layer 23 and the lowest unoccupied orbital energy level LUMO1 of the transition layer 24 satisfy that $0.4 \text{ eV} \leq |LUMO1 - LUMO2| \leq 1 \text{ eV}$.

[0027] It is to be understood that the array base substrate 10 may be a flexible base substrate, and the organic light-emitting display panel may be a flexible organic light-emitting display panel, which has low power consumption and flexible performance. The flexible organic light-emitting display panel is suitable for various display apparatuses, especially for wearable display apparatuses. In one or more embodiments, the flexible substrate is made of polyesterimide or polyethylene terephthalate resin. In addition, the array base substrate 10 may be a rigid substrate, and the organic light-emitting display panel is a rigid organic light-emitting display panel. The present disclosure does not specify the material of the organic light-emitting display panel.

[0028] In the organic light-emitting display panel provided in the present disclosure, the anode 21 of the each of the plurality of organic light-emitting devices 20 is in contact with a side surface of the array substrate 10. The organic luminous layer 22, the electron transport layer 23, the transition layer 24 and the cathode 25 are stacked successively on the anode 21. In the light-emitting process of the plurality of organic light-emitting devices 20, the driving element applies positive voltage to the anode 21. The material of the anode 21 may be indium tin oxide (ITO). In one or more embodiments, the anode 21 includes a reflective film, and the reflective film may be disposed on a side surface of the anode 21 facing away from the array base substrate 10, and a material of the reflective film may be Ag. The anode 21 may further includes a transparent conductive film on a side surface of the reflective film facing away from the array base substrate 10, and a material of the transparent conductive film may be ITO or indium zinc oxide (IZO).

[0029] In the light-emitting process of the plurality of organic light-emitting devices **20**, the driving element applies a negative voltage to the cathode **25**. In order to improve the injection capacity of electron carriers, the cathode **25** may be formed by using a metal material with a low work function, such as Ag, Al, Ca, In, Li, Mg and the like, or composite metal materials with a low work function.

[0030] In related arts, in the manufacturing process of the cathode **25** of the organic light-emitting devices **20**, the cathode **25** may form defects, affecting light transmittance and resulting in deterioration of luminescence performance. For example, when the cathode is formed by co-evaporation of magnesium and silver the thickness of the cathode is too thin, and easy to form in an island shape; and when the cathode is formed by silver separately, it is easy to gather and form defects, and when the thickness of the cathode is greater than 20 nm (greater than 200 Å), the light transmittance deteriorates.

[0031] FIG. 2 is a diagram showing light transport route between an organic luminous layer and a cathode according to an embodiment of the present disclosure. As shown in FIG. 2, light emitted by the organic luminous layer **22** arrives at the transition layer **24** through the electron transport layer **23**. As the refractive index n_1 of the transition layer **24** is greater than the refractive index n_2 of the electron transport layer **23**, according to Snell's Law (law of refraction): $n_1/n_2 = \sin \theta_2/\sin \theta_1$, it is obtained that $\theta_1 < \theta_2$, and light at the interface between the electron transport layer **23** and the transition layer **24** is extracted on the light outgoing side, increasing the light extraction rate. In one or more exemplary embodiments, the refractive index n_2 of the electron transport layer **23** is arranged to be greater than the refractive index n_3 of the organic luminous layer **22**, according to the law of refraction, it is obtained that in FIG. 2 $\theta_2 < \theta_3$, and light at the interface between the organic luminous layer **22** and the electron transport layer **23** is extracted again on the light outgoing side, increasing the light extraction rate. In this embodiment, the refractive index n_1 of the transition layer **24** for the visible light with the wavelength of 500 nm satisfies that $1.8 \leq n_1 \leq 2.2$. An optical absorption coefficient A of the transition layer **24** for the visible light with a wavelength of 500 nm satisfies that $A \leq 0.5\%$. Through an arrangement that the optical absorption coefficient A of the transition layer **24** for the visible light with the wavelength of 500 nm satisfies that $A \leq 0.5\%$, it can guarantee that the organic light-emitting device **20** has sufficient light emission efficiency.

[0032] In this embodiment, the lowest unoccupied orbital energy level LUMO1 of the transition layer **24** and a work function ϕ_1 of the cathode **25** satisfy that $0 \text{ eV} \leq |LUMO1 - \phi_1| \leq 2.6 \text{ eV}$. The lowest unoccupied orbital energy level LUMO2 of the electron transport layer **23** and the lowest unoccupied orbital energy level LUMO1 of the transition layer **24** satisfy that $0.4 \text{ eV} \leq |LUMO1 - LUMO2| \leq 1 \text{ eV}$. Through energy level matching between the lowest unoccupied orbital energy levels of the electron transport layer **23** and the lowest unoccupied energy level of the transition layer **24** and the work function of the cathode **25**, it is conducive to the migration of electron carriers, reducing the injection potential barrier of electrons, and facilitating the injection of more electrons to the organic luminous layer **22**.

[0033] It is to be understood that electrons carry with negative electricity and the migration of electrons is from a low energy level to a high energy level. It is more conducive

to the migration of electron and to improve the performance of organic light-emitting devices by setting $0 \text{ eV} \leq |LUMO1 - \phi_1| \leq 2.6 \text{ eV}$, $0.4 \text{ eV} \leq |LUMO1 - LUMO2| \leq 1 \text{ eV}$.

[0034] The organic light-emitting display panel provided in the present disclosure, through the arrangement that the refractive index of the transition layer is greater than the refractive index of the electron transport layer, can avoid the total reflection of light emitted by the organic light-emitting layer when the light passes through the interface between the electron transport layer and the transition layer. The organic light-emitting display panel provided in the present disclosure, through further arranging the relationship of the work function of the cathode, the lowest unoccupied orbital energy level of the transition layer and the lowest unoccupied orbital energy level of the electron transport layer, can reduce the electronic injection barrier, facilitate more electrons to be injected to the organic luminous layer, so as to increase the light extraction rate of organic light-emitting devices, effectively improve the luminous efficiency and improve the performance of organic light-emitting display panel.

[0035] In one or more embodiments, the lowest unoccupied orbital energy level LUMO1 of the transition layer and the work function ϕ_1 of the cathode satisfy that $1.0 \text{ eV} \leq |LUMO1 - \phi_1| \leq 2.0 \text{ eV}$. The lowest unoccupied orbital energy level LUMO2 of the electron transport layer and the lowest unoccupied orbital energy level LUMO1 of the transition layer satisfy that $0.5 \text{ eV} \leq |LUMO1 - LUMO2| \leq 0.7 \text{ eV}$.

[0036] Applicants have found that, through an arrangement where the lowest unoccupied orbital energy level LUMO1 of the transition layer and the work function ϕ_1 of the cathode satisfy that $1.0 \text{ eV} \leq |LUMO1 - \phi_1| \leq 2.0 \text{ eV}$ and the lowest unoccupied orbital energy level LUMO2 of the electron transport layer and the lowest unoccupied orbital energy level LUMO1 of the transition layer satisfy that $0.5 \text{ eV} \leq |LUMO1 - LUMO2| \leq 0.7 \text{ eV}$, the efficiency of electron injection and the performance of organic light-emitting device can be further improved.

[0037] In one or more embodiments, a highest occupied orbital energy level HOMO1 of the transition layer satisfies that $5.8 \text{ eV} \leq |HOMO1| \leq 6.4 \text{ eV}$. The lowest unoccupied orbital energy level LUMO1 of the transition layer satisfies that $2.2 \text{ eV} \leq |LUMO1| \leq 2.8 \text{ eV}$.

[0038] Taking an arrangement where the highest occupied orbital energy level HOMO1 of the transition layer satisfies that $5.8 \text{ eV} \leq |HOMO1| \leq 6.4 \text{ eV}$ and the lowest unoccupied orbital energy level LUMO1 of the transition layer satisfies that $2.2 \text{ eV} \leq |LUMO1| \leq 2.8 \text{ eV}$, it is able to match reasonable energy level differences among the transition layer, the cathode and electron transport layer, and electron injection efficiency is improved.

[0039] Further referring to FIG. 1, in one or more embodiments, the transition layer **24** is disposed adjacent to the cathode **25**, and the transition layer **24** is configured to improve morphology of a surface of the cathode **25** adjacent to the transition layer **24**. In one or more embodiments, a roughness of the surface of the cathode **25** adjacent to the transition layer **24** is less than the roughness of a surface of the cathode **25** facing away from the transition layer **24**.

[0040] It is to be understood that the transition layer **24** may shorten a dispersion length of the interface between the cathode **25** metal and the transition layer **24**, improve the

morphology and uniformity of the surface of the cathode **25**, reduce the optical waveguide effect and the contribution of the plasma on the surface of the cathode **25**, so as to increase light transmittance performance of the cathode **25**.

[0041] An image of the morphology of the surface of the cathode may be obtained by microscopic imaging the cathode by a scanning electron microscope. FIG. **3** is a morphology micrograph of a cathode of an organic light-emitting device according to an embodiment of the present disclosure, FIG. **4** is a morphology micrograph of a cathode of an organic light-emitting device according to a comparison embodiment of the present disclosure, and the organic light-emitting device in the comparison embodiment does not include the transition layer. With a comparison of FIG. **3** and FIG. **4**, the transition layer can improve the morphology of the surface of the cathode. FIG. **5** is a comparison diagram showing light transmittance of an organic light-emitting device according to a comparison embodiment and an embodiment of the present disclosure, the solid line is a light transmittance curve of the cathode of the organic light-emitting device provided in this embodiment, and the dash line is a light transmittance curve of the cathode of the organic light-emitting device provided in the comparison embodiment. As shown in FIG. **5**, the transition layer helps to increase light transmittance performance of the cathode and improve the performance of organic light-emitting device.

[0042] In one or more embodiment, the transition layer includes at least one of: a quinoline group, an oxazole group and a dinitrogen anthracene group.

[0043] The transition layer may be an organic compound including the quinoline group, the oxazole group or the dinitrogen anthracene group, the transition layer may be an organic matter, or a mixture of multiple organic matters, this embodiment does not intent to limit the transition layer. The organic compound including the quinoline group, the oxazole group or the dinitrogen anthracene group has a strong affinity with the metal forming the cathode, which can effectively shorten the dispersion length in a film forming process of the cathode metal, increase the light transmittance performance of the cathode and improve the performance of organic light-emitting device.

[0044] In one or more embodiment, a thickness d of the transition layer satisfies that $d \leq 30$ nm.

[0045] It is to be understood that if the transition layer is too thick, it may influence the performance of device. If the thickness of the transition layer is set to be less than or equal to 30 nm, good luminous performance can be obtained. Under the condition that the cathode has the same light transmittance, the thickness of the cathode may be increased from 10 nm~14 nm to 14 nm~19 nm, effectively reducing the cathode resistance and power consumption.

[0046] FIG. **6** is a structure diagram of an organic light-emitting device according to an embodiment of the present disclosure. As shown in FIG. **6**, in one or more embodiments, the transition layer **24** includes a first dopant **241**, and a work function φ_2 of the first dopant **241** is less than the work function φ_1 of the cathode **25**. In one or more embodiments, the first dopant **241** includes an alkaline earth metal element or a rare earth metal element.

[0047] It is to be understood that after doping elementary substances of some rare earth metals or alkaline earth metals, or compounds of some rare earth metals or alkaline earth metals, into the transition layer **24**, the interface

resistance between the cathode **25** and the transition layer **24** may be reduced, so as to improve the ability of the cathode **25** to inject the electrons to the transition layer **24**, and improve the response speed and luminescence efficiency of the organic light-emitting device. In this embodiment, the work function φ_2 of the first dopant **241** is less than the work function φ_1 of the cathode **25**. This arrangement may further improve the ability of the cathode **25** to inject the electrons to the transition layer **24**. Exemplarily, the first dopant **241** may be at least one of: Mg, Ga, Yb, Sm, Y, Tm, Gd and Lu.

[0048] FIG. **7** is a comparison diagram showing a cathode sheet resistance of an organic light-emitting device according to an embodiment and a comparison embodiment of the present disclosure. The solid line is a cathode sheet resistance curve at different point of the organic light-emitting device in this embodiment, and the dash line is a cathode sheet resistance curve at different point of the organic light-emitting device in the comparison embodiment. As shown in FIG. **7**, the organic light-emitting device provided in this embodiment can significantly reduce the cathode sheet resistance and improve the performance of the organic light-emitting device.

[0049] FIG. **8** is a structure diagram of an organic light-emitting device according to an embodiment of the present disclosure. As shown in FIG. **8**, in one or more exemplary embodiments, the electron transport layer **23** includes a second dopant **231**, and a work function φ_3 of the second dopant **231** is less than or equal to the work function φ_2 of the first dopant **241**. In one or more exemplary embodiments, the second dopant **231** includes an alkaline earth metal element or a rare earth metal element.

[0050] Exemplarily, the second dopant **231** may be at least one of: Mg, Ga, Yb, Sm, Y, Tm, Gd and Lu, and the second dopant **231** may improve the electron transport capacity of the electron transport layer **23** and the performance of the organic light-emitting device.

[0051] It is understandable that the first dopant **241** and the second dopant **231** may use the same element or different elements. When the first dopant **241** and the second dopant **231** use the same element, the same process may be used in implementation, which is conducive to reduce cost.

[0052] FIG. **9** is a structure diagram of another organic light-emitting device according to an embodiment of the present disclosure. As shown in FIG. **9**, in one or more exemplary embodiments, an electron injection layer **26** is further disposed between the cathode **25** and the electron transport layer **23**. In one or more exemplary embodiments, the electron injection layer **26** is disposed between the electron transport layer **23** and the transition layer **24**, and a lowest unoccupied orbital energy level LUMO3 of the electron injection layer **26**, the lowest unoccupied orbital energy level LUMO1 of the transition layer **24** and the lowest unoccupied orbital energy level LUMO2 of the electron transport layer **23** satisfy that $|LUMO2| \leq |LUMO3| \leq |LUMO1|$.

[0053] Through disposing the electron injection layer **26** and setting an energy level of the electron injection layer **26**, the electron injection efficiency of the device and luminescence performance of the device are further improved.

[0054] FIG. **10** is a structure diagram of another organic light-emitting device according to an embodiment of the present disclosure. As shown in FIG. **10**, in one or more exemplary embodiments, the electron injection layer **26** is disposed between the transition layer **24** and the cathode **25**,

and the electron injection layer 26 includes at least one of: a rare earth metal and an alkaline earth metal.

[0055] Exemplarily, the electron injection layer 26 may be formed by using elements such as Yb and Sm to form a thin layer, which is disposed between the cathode 25 and the transition layer 24 to improve the electronic injection efficiency of the device.

[0056] FIG. 11 is a structure diagram of an organic light-emitting display device according to an embodiment of the present disclosure. As shown in FIG. 11, the organic light-emitting display apparatus 1 includes any organic light-emitting display panel 2 provided in embodiments of the present disclosure. The organic light-emitting display apparatus 1 may be a mobile phone, a computer, a smart wearable device, and the like.

[0057] The organic light-emitting display apparatus provided in embodiments of the present disclosure, including the organic light-emitting display panel described above, realizes all the beneficial effects of the organic light-emitting display panel described above. That is, the embodiments of present disclosure provides an arrangement where a refractive index n_1 of the transition layer of the organic light-emitting device for the visible light with the wavelength of 500 nm and a refractive index n_2 of the electron transport layer of the organic light-emitting device for the visible light with the wavelength of 500 nm satisfy that $0.05 \leq n_1 - n_2 \leq 0.4$, namely, the refractive index of the transition layer is greater than the refractive index of the electron transport layer. Such arrangement can avoid full reflection of light emitted by the organic luminous layer when the light passes through the interface between the electron transport layer and the transition layer, improving the extraction rate of light. The embodiments of the present disclosure provide an arrangement where a lowest unoccupied orbital energy level LUMO1 of the transition layer and a work function ϕ_1 of the cathode satisfy that $0 \text{ eV} \leq |LUMO1 - \phi_1| \leq 2.6 \text{ eV}$, which can facilitate migration of electron carriers. The embodiments of the present disclosure provide an arrangement where a lowest unoccupied orbital energy level LUMO2 of the electron transport layer and the lowest unoccupied orbital energy level LUMO1 of the transition layer satisfy that $0.4 \text{ eV} \leq |LUMO1 - LUMO2| \leq 1 \text{ eV}$, and a difference of lowest energy level between the electron transport layer and the transition layer is small, which can reduce electron injection potential barrier and facilitate more electrons to be injected into the organic luminous layer, so as to improve the light extraction rate of organic light-emitting devices, effectively improve the luminous efficiency and improve the performance of the organic light-emitting display panel.

[0058] It should be noted that the above contents are only optional embodiments of the present disclosure and its technical principles. It can be understood for those skilled in the art that the present disclosure is not limited to specific embodiments described herein. For those skilled in the art, the present disclosure can be subject to various apparent variations, readjustments and replacements without departing from a protection scope of the present disclosure. Therefore, although the present disclosure is described in detail through above embodiments, the present disclosure is not only limited to above embodiments. The present disclosure can also include more other equivalent embodiments without deviating from conceptions of the present disclosure. A scope of the present disclosure is determined by a scope of attached claims.

What is claimed is:

1. An organic light-emitting display panel, comprising: an array base substrate, wherein the array base substrate comprises a plurality of driving elements; and a plurality of organic light-emitting devices, wherein each of the plurality of organic light-emitting devices is corresponding to a respective one of the plurality of driving elements, the each of the plurality of organic light-emitting devices comprises an anode, a cathode, an organic luminous layer, an electron transport layer, and a transition layer, wherein, the organic luminous layer is disposed between the anode and the cathode; the electron transport layer is disposed between the emitting material layer and the cathode; the transition layer is disposed between the cathode and the electron transport layer, and the transition layer comprises an organic material; a refractive index n_1 of the transition layer for visible light with a wavelength of 500 nm and a refractive index n_2 of the electron transport layer for the visible light with a wavelength of 500 nm satisfy that $0.05 \leq n_1 - n_2 \leq 0.4$; a lowest unoccupied orbital energy level LUMO1 of the transition layer and a work function ϕ_1 of the cathode satisfy that $0 \text{ eV} \leq |LUMO1 - \phi_1| \leq 2.6 \text{ eV}$; and a lowest unoccupied orbital energy level LUMO2 of the electron transport layer and the lowest unoccupied orbital energy level LUMO1 of the transition layer satisfy that $0.4 \text{ eV} \leq |LUMO1 - LUMO2| \leq 1 \text{ eV}$.
2. The organic light-emitting display panel according to claim 1, wherein the transition layer is disposed adjacent to the cathode, and the transition layer is configured to improve morphology of a surface of the cathode adjacent to the transition layer.
3. The organic light-emitting display panel according to claim 2, wherein a roughness of the surface of the cathode adjacent to the transition layer is less than a roughness of a surface of the cathode facing away from the transition layer.
4. The organic light-emitting display panel according to claim 1, wherein the lowest unoccupied orbital energy level LUMO1 of the transition layer and the work function ϕ_1 of the cathode satisfy that $1.0 \text{ eV} \leq |LUMO1 - \phi_1| \leq 2.0 \text{ eV}$; and the lowest unoccupied orbital energy level LUMO2 of the electron transport layer and the lowest unoccupied orbital energy level LUMO1 of the transition layer satisfy that $0.5 \text{ eV} \leq |LUMO1 - LUMO2| \leq 0.7 \text{ eV}$.
5. The organic light-emitting display panel according to claim 1, wherein the transition layer comprises at least one of: a quinoline group, an oxazole group and a dinitrogen anthracene group.
6. The organic light-emitting display panel according to claim 1, wherein the refractive index n_1 of the transition layer for the visible light with the wavelength of 500 nm satisfies that $1.8 \leq n_1 \leq 2.2$.
7. The organic light-emitting display panel according to claim 1, wherein an optical absorption coefficient A of the transition layer for the visible light with the wavelength of 500 nm satisfies that $A \leq 0.5\%$.
8. The organic light-emitting display panel according to claim 1, wherein a highest occupied orbital energy level HOMO1 of the transition layer satisfies that $5.8 \text{ eV} \leq |HOMO1| \leq 6.4 \text{ eV}$; and

the lowest unoccupied orbital energy level LUMO1 of the transition layer satisfies that $2.2 \text{ eV} \leq |LUMO1| \leq 2.8 \text{ eV}$.

9. The organic light-emitting display panel according to claim 1, wherein a thickness d of the transition layer satisfies that $d \leq 30 \text{ nm}$.

10. The organic light-emitting display panel according to claim 1, wherein the transition layer comprises a first dopant, and a work function φ_2 of the first dopant is less than the work function φ_1 of the cathode.

11. The organic light-emitting display panel according to claim 10, wherein the first dopant comprises an alkaline earth metal element or a rare earth metal element.

12. The organic light-emitting display panel according to claim 10, wherein the electron transport layer comprises a second dopant, and a work function φ_3 of the second dopant is less than or equal to the work function φ_2 of the first dopant.

13. The organic light-emitting display panel according to claim 12, wherein the second dopant comprises an alkaline earth metal element or a rare earth metal element.

14. The organic light-emitting display panel according to claim 1, further comprising an electron injection layer disposed between the cathode and the electron transport layer.

15. The organic light-emitting display panel according to claim 14, wherein the electron injection layer is disposed between the electron transport layer and the transition layer, and a lowest unoccupied orbital energy level LUMO3 of the electron injection layer, the lowest unoccupied orbital energy level LUMO1 of the transition layer and the lowest unoccupied orbital energy level LUMO2 of the electron transport layer satisfy that $|LUMO2| \leq |LUMO3| \leq |LUMO1|$.

16. The organic light-emitting display panel according to claim 14, wherein the electron injection layer is disposed between the transition layer and the cathode, and the electron injection layer comprises at least one of: a rare earth metal and an alkaline earth metal.

17. An organic light-emitting display apparatus, comprising a display panel, wherein the display panel comprises:

- an array base substrate, wherein the array base substrate comprises a plurality of driving elements; and
- a plurality of organic light-emitting devices, wherein each of the plurality of organic light-emitting devices is corresponding to a respective one of the plurality of

driving elements, the each of the plurality of organic light-emitting devices comprises an anode, a cathode, an organic luminous layer, an electron transport layer, and a transition layer, wherein,

the organic luminous layer is disposed between the anode and the cathode;

the electron transport layer is disposed between the organic luminous layer and the cathode;

the transition layer is disposed between the cathode and the electron transport layer, and the transition layer comprises an organic material;

an refractive index n_1 of the transition layer for visible light with a wavelength of 500 nm and an refractive index n_2 of the electron transport layer for the visible light with a wavelength of 500 nm satisfy that $0.05 \leq n_1 - n_2 \leq 0.4$;

a lowest unoccupied orbital energy level LUMO1 of the transition layer and a work function φ_1 of the cathode satisfy that $0 \text{ eV} \leq |LUMO1 - \varphi_1| \leq 2.6 \text{ eV}$; and

a lowest unoccupied orbital energy level LUMO2 of the electron transport layer and the lowest unoccupied orbital energy level LUMO1 of the transition layer satisfy that $0.4 \text{ eV} \leq |LUMO1 - LUMO2| \leq 1 \text{ eV}$.

18. The organic light-emitting display apparatus according to claim 17, wherein the transition layer is disposed adjacent to the cathode, and the transition layer is configured to improve morphology of a surface of the cathode adjacent to the transition layer.

19. The organic light-emitting display apparatus according to claim 18, wherein a roughness of the surface of the cathode adjacent to the transition layer is less than a roughness of a surface of the cathode facing away from the transition layer.

20. The organic light-emitting display apparatus according to claim 17, wherein the lowest unoccupied orbital energy level LUMO1 of the transition layer and the work function φ_1 of the cathode satisfy that $1.0 \text{ eV} \leq |LUMO1 - \varphi_1| \leq 2.0 \text{ eV}$; and

the lowest unoccupied orbital energy level LUMO2 of the electron transport layer and the lowest unoccupied orbital energy level LUMO1 of the transition layer satisfy that $0.5 \text{ eV} \leq |LUMO1 - LUMO2| \leq 0.7 \text{ eV}$.

* * * * *

专利名称(译)	有机发光显示面板和有机发光显示装置		
公开(公告)号	US20200044182A1	公开(公告)日	2020-02-06
申请号	US16/244227	申请日	2019-01-10
[标]申请(专利权)人(译)	上海天马AM OLED		
申请(专利权)人(译)	上海天马AM-OLED CO. , LTD.		
当前申请(专利权)人(译)	上海天马AM-OLED CO. , LTD.		
[标]发明人	NIU JINGHUA		
发明人	QIAO, WEILI NIU, JINGHUA SUN, XIAOQIAN		
IPC分类号	H01L51/52 H01L27/32 H01L51/50		
CPC分类号	H01L2251/552 H01L51/5004 H01L51/5072 H01L27/3244 H01L51/5262 H01L51/5092 H01L51/5221 H01L27/32 H01L51/5064 H01L51/5076 H01L51/5234 H01L51/5275 H01L51/00		
优先权	201810862737.2 2018-08-01 CN		
外部链接	Espacenet USPTO		

摘要(译)

提供了一种有机发光显示面板和一种有机发光显示装置。有机发光显示面板包括具有多个驱动元件的阵列基底，并且包括多个有机发光装置。多个有机发光器件中的每个对应于多个驱动元件中的每个，并且多个有机发光器件中的每个包括阳极和阴极，阴极，有机发光层，电子传输层和过渡层。有机发光层设置在阳极和阴极之间，电子传输层设置在发光层和阴极之间，过渡层设置在阴极和电子传输层之间，并且过渡层包括有机材料。。

